

# CNE Series

## Sensor connector

NEW

### ■ Features

- **Wire mount plug/socket**
  - Compact and highly reliable of pressure welding connector
  - Enables to connect wires as wire mount plug/socket
  - Different 9 colors of cover by wire diameter
  - Visible wiring status with translucent cover
- **Board mount socket**
  - Enables to insert 4EA, 2EA, or 1EA wire mount plugs
  - Contact placed in mold against electric shock and short-circuit
  - Mountable on board closely
- **Commons**
  - Significantly reduces connection time and effort
  - Wide products range for various wires
  - Compact and high density installation with 2 mm of contact pitch
  - Compliance with e-CON
  - Max. 3 A of current capacity by a pin



### ■ Ordering information

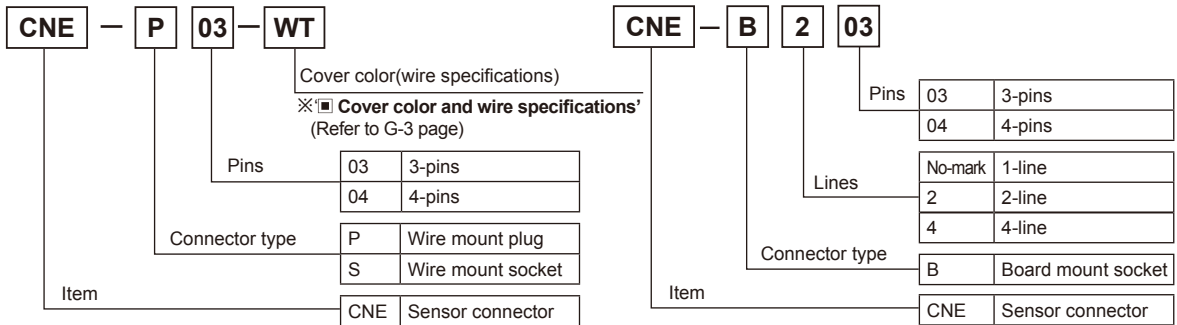

### ■ Specifications

Type	Wire mount plug	Wire mount socket	Board mount socket
Model	CNE-P□□	CNE-S□□	CNE-B□□
Applica- tion	Connector	Board mount socket/Wire mount socket	Wire mount plug
	Cable	AWG30 to 20(Ø0.6 to Ø2.0)	
	PCB	— Fender plated-through hole, Hole dia.: 1.0mm, PCB thickness : 1.0 to 2.2mm	
Rated voltage	Max. 250VAC/DC		
Rated current	Max. 3.0A		
Temperature	-20 to 85°C(applying 1A), -20 to 75°C(applying 2A), -20 to 60°C(applying 3A)		
Humidity	40 to 80%RH		
Terminal retention	1.4kgf min.		
Pressure strength	• AWG30 : 0.5kgf min.      • AWG24 : 0.8kgf min.      • AWG20 : 1.0kgf min.		
Extraction	0.49N(50gf)/pin min.		
Insertion	1.96N(200gf)/pin max.		
Dielectric strength	1,000VAC for 1min.(between terminals)		
Insulated resistance	Min. 1,000MΩ(between terminals)		
Contact resistance	Max. 0.05Ω (short-current : 1mA, max. open voltage : 20mV)		
Material	Body : PCABS(UL94V-0), Terminal : C5210(Gold 0.2μm), Case : PC(UL94-V0)		Body : PCABS(UL94-V0), Terminal : C5210(Gold 0.2μm)

# Sensor Connector

## Cover color and wire specifications

Cover color	3-pin	4-pin	Applied wire specifications	
			Normal cross section area(mm <sup>2</sup> )	Cover diameter(mm)
Transparent(WT)	CNE-□03-WT	CNE-□04-WT	0.05 to 0.08 (AWG30 to 28)	∅0.6 to 0.8
Yellow-Green(YG)	CNE-□03-YG	CNE-□04-YG		∅0.8 to 1.0
Violet(VT)	CNE-□03-VT	CNE-□04-VT		∅1.0 to 1.2
Red(RE)	CNE-□03-RE	CNE-□04-RE	0.13 to 0.21 (AWG26 to 24)	∅0.8 to 1.0
Yellow(YW)	CNE-□03-YW	CNE-□04-YW		∅1.0 to 1.2
Orange(OG)	CNE-□03-OG	CNE-□04-OG	0.32 to 0.5 (AWG22 to 20)	∅1.2 to 1.6
Green(GN)	CNE-□03-GN	CNE-□04-GN		∅1.0 to 1.2
Blue(BL)	CNE-□03-BL	CNE-□04-BL		∅1.2 to 1.6
Gray(GY)	CNE-□03-GY	CNE-□04-GY		∅1.6 to 2.0

※ □ : P(Wire mount plug), S(Wire mount socket)

## Dimensions

### Wire mount plug

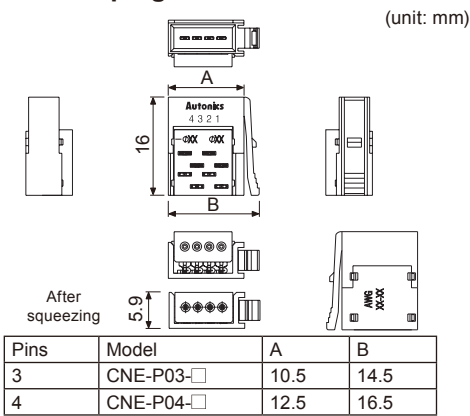

### Wire mount socket

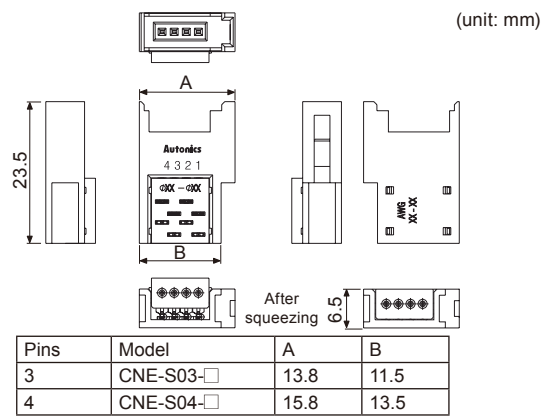

### Board mount socket

#### ● CNE-B03(1-line×3-pin)

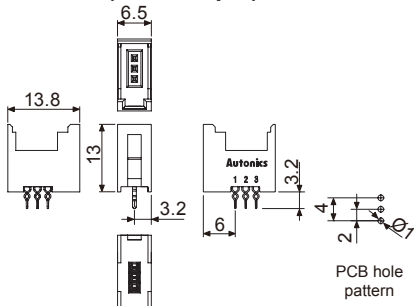

#### ● CNE-B04(1-line×4-pin)

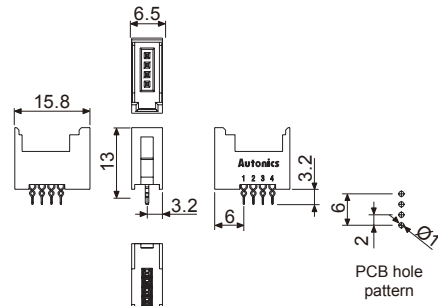

#### ● CNE-B203(2-line×3-pin)

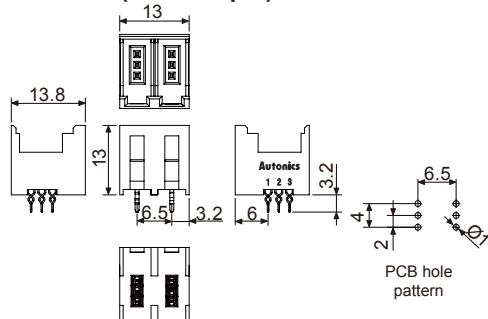

#### ● CNE-B204(2-line×4-pin)

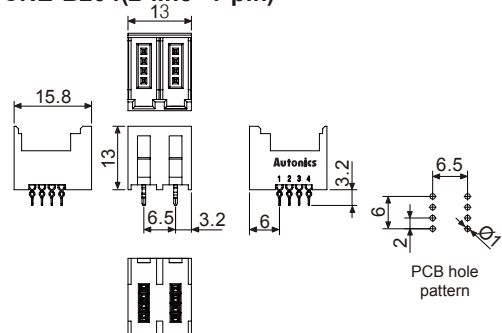

(A) Photo electric sensor

(B) Fiber optic sensor

(C) Door/Area sensor

(D) Proximity sensor

(E) Pressure sensor

(F) Rotary encoder

(G) Connector/Socket

(H) Temp. controller

(I) SSR/ Power controller

(J) Counter

(K) Timer

(L) Panel meter

(M) Tacho/ Speed/ Pulse meter

(N) Display unit

(O) Sensor controller

(P) Switching mode power supply

(Q) Stepper motor& Driver&Controller

(R) Graphic/ Logic panel

(S) Field network device

(T) Software

(U) Other

# CNE Series

## ◎ Board mount socket

(unit: mm)

### ● CNE-B403(4-line×3-pin)

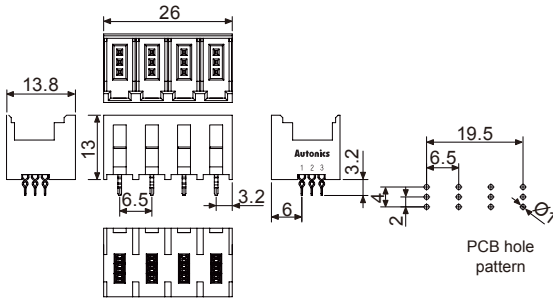

### ● CNE-B404(4-line×4-pin)

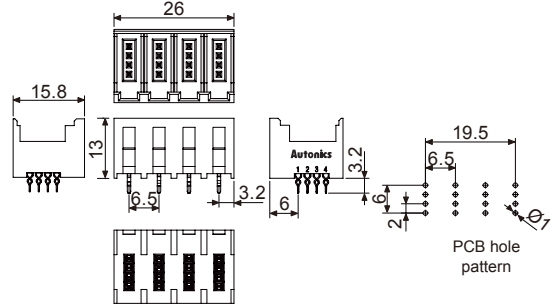

## ■ How to press sensor connector

### 1) Select connector.

- Check the wire specifications (conductor section, cover diameter).
- Select the proper color of sensor connector(model) by referring to the below table.

Cover color	Wire mount plug	Wire mount socket	Applied wire specifications	
			Nominal cross section area(mm <sup>2</sup> )	Cover diameter(mm)
Transparent(WT)	CNE-P□-WT	CNE-S□-WT	0.05 to 0.08 (AWG30 to 28)	∅0.6 to 0.8
Yellow-Green(YG)	CNE-P□-YG	CNE-S□-YG		∅0.8 to 1.0
Violet(VT)	CNE-P□-VT	CNE-S□-VT		∅1.0 to 1.2
Red(RE)	CNE-P□-RE	CNE-S□-RE	0.13 to 0.21 (AWG26 to 24)	∅0.8 to 1.0
Yellow(YW)	CNE-P□-YW	CNE-S□-YW		∅1.0 to 1.2
Orange(OG)	CNE-P□-OG	CNE-S□-OG		∅1.2 to 1.6
Green(GN)	CNE-P□-GN	CNE-S□-GN	0.32 to 0.5 (AWG22 to 20)	∅1.0 to 1.2
Blue(BL)	CNE-P□-BL	CNE-S□-BL		∅1.2 to 1.6
Gray(GY)	CNE-P□-GY	CNE-S□-GY		∅1.6 to 2.0

※□: Number of pins (03: 3-pin, 04: 4-pin)

※The proper sensor connector may be different by conductor of wire.

※Cover diameter of applied wire at connector (at translucent part) and AWG number of body backside are marked.



### 2) Insert wires.

- Check the pin number and insert wires at the insertion part of the cover.
- Check the wires are inserted at the end of cover.

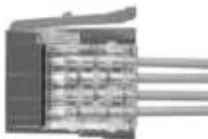

### 3) Squeeze the connector.

- Insert the cover to the body with tools (press fitting pliers, etc).
- ※Squeeze it with tools at the side direction as below figure.



### 4) Check the cover.

- Check the cover which has gaps and is even with the cover.



Wrong (1)

Wrong (2)

Not enough cover insertion.

Not enough cover insertion.

※Press the part of arrows again.